



# RUTX10

## PROFESSIONAL ETHERNET ROUTER



Energy & utilities



Enterprise



Industrial & automation



Retail



Smart city

### GIGABIT ETH

4 x Gigabit Ethernet ports with up to 128 port/tag-based VLANs supported

### WI-FI & BT

Wave-2 802.11ac Dual Band Wi-Fi and Bluetooth LE

### VPN

Numerous VPN Protocols supported, including OpenVPN, IPsec, PPTP, L2TP & DMVPN

### RMS

Compatible with Teltonika Networks Remote Management System

## Ethernet

WAN	1 x WAN port 10/100/1000 Mbps, compliance with IEEE 802.3, IEEE 802.3u, 802.3az standards, supports auto MDI/MDIX crossover
LAN	3 x LAN ports, 10/100/1000 Mbps, compliance with IEEE 802.3, IEEE 802.3u, 802.3az standards, supports auto MDI/MDIX crossover

## Wireless

Wireless mode	802.11b/g/n/ac Wave 2 (Wi-Fi 5) with data transmission rates up to 867 Mbps (Dual Band, MU-MIMO), 802.11r fast transition, Access Point (AP), Station (STA)
Wi-Fi security	WPA2-Enterprise: PEAP, WPA2-PSK, WPA-EAP, WPA-PSK, WPA3-SAE, WPA3-EAP, OWE; AES-CCMP, TKIP, Auto-cipher modes, client separation, EAP-TLS with PKCS#12 certificates, disable auto-reconnect, 802.11w Protected Management Frames (PMF)
SSID/ESSID	SSID stealth mode and access control based on MAC address
Wi-Fi users	Up to 150 simultaneous connections
Wireless Connectivity Features	Wireless mesh (802.11s), fast roaming (802.11r), Relayd, BSS transition management (802.11v), radio resource measurement (802.11k)
Wireless MAC filter	Allowlist, blocklist
Wireless QR code generator	Once scanned, a user will automatically enter your network without needing to input login information
TravelMate	Forward Wi-Fi hotspot landing page to a subsequent connected device

## Security

Certificate Manager	Certificate creation tool allows to create CA, server, client, let's encrypt, SCEP certificates
802.1x	Port-based network access control client
Authentication	Pre-shared key, digital certificates, X.509 certificates, TACACS+, Internal & External RADIUS users authentication, IP & login attempts block, time-based login blocking, built-in random password generator
Firewall	Preconfigured firewall rules can be enabled via WebUI, unlimited firewall configuration via CLI, DMZ, NAT, NAT-T, NAT64
Attack prevention	DDOS prevention (SYN flood protection, SSH attack prevention, HTTP/HTTPS attack prevention), port scan prevention (SYN-FIN, SYN-RST, X-mas, NULL flags, FIN scan attacks)
VLAN	Port and tag-based VLAN separation
WEB filter	Block list for blocking out unwanted websites, allow list for specifying allowed sites only
Access control	Flexible access control of SSH, Web interface, CLI and Telnet
TPM	Identification and authentication module, TPM 2.0 standard
	*Feature availability varies by order code

## Bluetooth

Bluetooth 5.0	Bluetooth low energy (LE) for short range communication
---------------	---

**Network**

Routing	Static routing, Dynamic routing (BGP, OSPF v2, RIP v1/v2, EIGRP, NHRP), Policy based routing
Network protocols	TCP, UDP, IPv4, IPv6, ICMP, NTP, DNS, HTTP, HTTPS, SFTP, FTP, SMTP, SSL/TLS, ARP, VRRP, PPP, PPPoE, UPNP, SSH, DHCP, Telnet, SMPP, SNMP, MQTT, Wake On Lan (WOL), VXLAN
VoIP passthrough support	H.323 and SIP-alg protocol NAT helpers, allowing proper routing of VoIP packets
Connection monitoring	Ping Reboot, Wget Reboot, Periodic Reboot, LCP and ICMP for link inspection
Firewall	Port forward, traffic rules, custom rules, TTL target customisation
Firewall status page	View all your Firewall statistics, rules, and rule counters
Port management	View device ports, enable and disable each of them, turn auto-configuration on or off, change their transmission speed, and so on
Network topology	Visual representation of your network, showing which devices are connected to which other devices
Hotspot	Captive portal (hotspot), internal/external Radius server, Radius MAC authentication, SMS authorisation, SSO authentication, internal/external landing page, walled garden, user scripts, URL parameters, user groups, individual user or group limitations, user management, 9 default customisable themes and optionality to upload and download customised hotspot themes
DHCP	Static and dynamic IP allocation, DHCP relay, DHCP server configuration, status, static leases: MAC with wildcards
QoS / Smart Queue Management (SQM)	Traffic priority queuing by source/destination, service, protocol or port, WMM, 802.11e
DDNS	Supported >77 service providers, others can be configured manually
DNS over HTTPS	DNS over HTTPS proxy enables secure DNS resolution by routing DNS queries over HTTPS
Network backup	Wi-Fi WAN, VRRP, Wired options, each of which can be used as an automatic Failover
Load balancing	Balance Internet traffic over multiple WAN connections
SSHFS	Possibility to mount remote file system via SSH protocol
VRF support	Initial virtual routing and forwarding (VRF) support
Traffic Management	Real-time monitoring, wireless signal charts, traffic usage history

## VPN

OpenVPN	Multiple clients and a server can run simultaneously, 27 encryption methods
OpenVPN Encryption	DES-CBC 64, RC2-CBC 128, DES-EDE-CBC 128, DES-EDE3-CBC 192, DESX-CBC 192, BF-CBC 128, RC2-40-CBC 40, CAST5-CBC 128, RC2-64-CBC 64, AES-128-CBC 128, AES-128-CFB 128, AES-128-CFB1 128, AES-128-CFB8 128, AES-128-OFB 128, AES-128-GCM 128, AES-192-CFB 192, AES-192-CFB1 192, AES-192-CFB8 192, AES-192-OFB 192, AES-192-CBC 192, AES-192-GCM 192, AES-256-GCM 256, AES-256-CFB 256, AES-256-CFB1 256, AES-256-CFB8 256, AES-256-OFB 256, AES-256-CBC 256
IPsec	XFRM, IKEv1, IKEv2, with 14 encryption methods for IPsec (3DES, DES, AES128, AES192, AES256, AES128GCM8, AES192GCM8, AES256GCM8, AES128GCM12, AES192GCM12, AES256GCM12, AES128GCM16, AES192GCM16, AES256GCM16)
GRE	GRE tunnel, GRE tunnel over IPsec support
PPTP, L2TP	Client/Server instances can run simultaneously, L2TPv3, L2TP over IPsec support
Stunnel	Proxy designed to add TLS encryption functionality to existing clients and servers without any changes in the program's code
DMVPN	Method of building scalable IPsec VPNs, Phase 2 and Phase 3 and Dual Hub support
SSTP	SSTP client instance support
ZeroTier	ZeroTier VPN client support
WireGuard	WireGuard VPN client and server support
Tinc	Tinc offers encryption, authentication and compression in it's tunnels. Client and server support.
Tailscale	Tailscale offers speed, stability, and simplicity over traditional VPNs. Encrypted point-to-point connections using the open source WireGuard protocol

## OPC UA

Supported modes	Client, Server
Supported connection types	TCP

## MODBUS

Supported modes	Server, Client
Supported connection types	TCP, USB
Custom registers	MODBUS TCP custom register block requests, which read/write to a file inside the router, and can be used to extend MODBUS TCP Client functionality
Supported data formats	8-bit: INT, UINT; 16-bit: INT, UINT (MSB or LSB first); 32-bit: float, INT, UINT (ABCD (big-endian), DCBA (little-endian), CDAB, BADC), HEX, ASCII

### Data to Server

Protocol	HTTP(S), MQTT, Azure MQTT
Data to server	Extract parameters from multiple sources and different protocols, and send them all to a single server; Custom LUA scripting, allowing scripts to utilize the router's Data to server feature

### MQTT Gateway

Modbus MQTT Gateway	Allows sending commands and receiving data from MODBUS Server through MQTT broker
---------------------	---

### DNP3

Supported modes	Station, Outstation
Supported connection	TCP, USB

### DLMS/COSEM

DLMS Support	DLMS - standard protocol for utility meter data exchange
Supported modes	Client
Supported connection types	TCP, USB

### API

Teltonika Networks Web API (beta) support	Expand your device's possibilities by using a set of configurable API endpoints to retrieve or change data. For more information, please refer to this documentation: <a href="https://developers.teltonika-networks.com">https://developers.teltonika-networks.com</a>
---	---

### Monitoring & Management

WEB UI	HTTP/HTTPS, status, configuration, FW update, CLI, troubleshoot, multiple event log servers, firmware update availability notifications, event log, system log, kernel log, Internet status
FOTA	Firmware update from server, automatic notification
SSH	SSH (v1, v2)
TR-069	OpenACS, EasyCwmp, ACSLite, tGem, LibreACS, GenieACS, FreeACS, LibCWMP, Friendly tech, AVSystem
MQTT	MQTT Broker, MQTT publisher
SNMP	SNMP (v1, v2, v3), SNMP Trap, Brute force protection
JSON-RPC	Management API over HTTP/HTTPS
RMS	Teltonika Remote Management System (RMS)

### IoT Platforms

ThingWorx	Allows monitoring of: WAN Type, WAN IP
Cumulocity - Cloud of Things	Allows monitoring of: Device Model, Revision and Serial Number, WAN Type and IP. Has reboot and firmware upgrade actions
Azure IoT Hub	Can be configured with Data to Server to send all the available parameters to the cloud. Has Direct method support which allows to execute RutOS API calls on the IoT Hub. Also has Plug and Play integration with Device Provisioning Service that allows zero-touch device provisioning to IoT Hubs

### System Characteristics

CPU	Quad-core ARM Cortex A7, 717 MHz
RAM	256 MB, DDR3
FLASH storage	256 MB, SPI Flash

### Firmware/Configuration

WEB UI	Update FW from file, check FW on server, configuration profiles, configuration backup
FOTA	Update FW
RMS	Update FW/configuration for multiple devices at once
Keep settings	Update FW without losing current configuration
Factory settings reset	A full factory reset restores all system settings, including the IP address, PIN, and user data to the default manufacturer's configuration

### FIRMWARE CUSTOMISATION

Operating system	RutOS (OpenWrt based Linux OS)
Supported languages	Busybox shell, Lua, C, C++, and Python, Java in Package manager
Development tools	SDK package with build environment provided
GPL customization	You can create your own custom, branded firmware and web page application by changing colours, logos, and other elements in our firmware to fit your or your clients' needs
Package Manager	The Package Manager is a service used to install additional software on the device

### Location Tracking

NTRIP	NTRIP protocol (Networked Transport of RTCM via Internet Protocol)
-------	--

### USB

Data rate	USB 2.0
Applications	Samba share, USB-to-serial
External devices	Possibility to connect external HDD, flash drive, additional modem, printer, USB-serial adapter
Storage formats	FAT, FAT32, exFAT, NTFS (read-only), ext2, ext3, ext4

### Input/Output

Input	1 x Digital Input, 0 - 6 V detected as logic low, 8 - 30 V detected as logic high
Output	1 x Digital Output, Open collector output, max output 30 V, 300 mA
Events	Email, RMS
I/O juggler	Allows to set certain I/O conditions to initiate event

### Power

Connector	4-pin industrial DC power socket
Input voltage range	9 - 50 VDC, reverse polarity protection, voltage surge/transient protection
PoE (passive)	Possibility to power up through LAN1 port, not compatible with IEEE802.3af, 802.3at and 802.3bt standards, Mode B, 9 - 50 VDC
Power consumption	9 W Max

### Physical Interfaces

Ethernet	4 x RJ45 ports, 10/100/1000 Mbps
I/O's	1 x Digital Input, 1 x Digital Output on 4-pin power connector
Status LEDs	8 x LAN status LEDs, 1 x Power LED, 2 x 2.4G and 5G Wi-Fi LEDs
Power	1 x 4-pin power connector
Antennas	2 x RP-SMA for Wi-Fi, 1 x RP-SMA for Bluetooth
USB	1 x USB A port for external devices
Reset	Reboot/User default reset/Factory reset button
Other	1 x Grounding screw

### Physical Specification

Casing material	Aluminium housing
Dimensions (W x H x D)	115 x 32.2 x 95.2 mm
Weight	355 g
Mounting options	DIN rail, wall mount, flat surface (all require additional kit)

### Operating Environment

Operating temperature	-40 °C to 75 °C
Operating humidity	10% to 90% non-condensing
Ingress Protection Rating	IP30

### Regulatory & Type Approvals

Regulatory	CE, UKCA, FCC, EAC, UCRF, CITC, ICASA, ANRT, FCC, IC, NOM, UL/CSA Safety, Anatel, Giteki, CB, IC (ISED), RCM
------------	--

**EMC Emissions & Immunity**

ESD	EN 61000-4-2:2009
Standards	CE/UKCA: EN 55032:2015 + A11:2020 + A1:2020 EN 55035:2017 + A11:2020 EN IEC 61000-3-2:2019 + A1:2021 + A2:2024 EN 61000-3-3:2013 + A1:2019 + A2:2021 EN 301 489-1 V2.2.3 EN 301 489-3 V2.3.2 EN 301 489-17 V3.3.1  FCC/ISED(IC): 47 CFR Part 15 Subpart B ICES-003: Issue 7 (October 2020)  RCM: AS/NZS CISPR 32:2015 + A1

Radiated Immunity	EN IEC 61000-4-3:2006 + A1:2008 + A2:2010 EN IEC 61000-4-3:2020
-------------------	--

EFT	EN 61000-4-4: 2012
-----	--------------------

Surge Immunity (AC Mains Power Port)	EN 61000-4-5:2014 + A1:2017
--------------------------------------	-----------------------------

CS	EN 61000-4-6:2014
----	-------------------

DIP	EN 61000-4-11:2004 EN 61000-4-11:2020
-----	--

**RF**

Standards	CE/UKCA: EN 300 328 V2.2.2 EN 301 893 V2.1.1 EN 300 440 V2.2.1  RCM: AS/NZS 4268:2017+A1:2021
-----------	---

Standards (Wi-Fi 2.4 GHz, 5 GHz)	FCC: 47 CFR Part 15 Subpart C - § 15.247, Subpart E - § 15.407 KDB 905462 D02 UNII DFS Compliance Procedures New Rules v02 KDB 905462 D04 Operational Modes for DFS Testing New Rules v01  IC (ISED): RSS-247 Issue 3 (August 2023) RSS-Gen Issue 5 (April 2018) Amendment 2 (February 2021)
----------------------------------	---

**RF Exposure**

Standards	FCC: 47 CFR - § 2.1091 KDB 447498 D04 Interim General RF Exposure Guidance v01  IC (ISED): RSS-102 Issue 6 (December 2023)
-----------	---

**Safety**

---

## Standards

CE: EN IEC 62368-1:2020 + A11:2020, EN IEC 62311:2020  
CB: IEC 62368-1:2018  
RCM: AS/NZS 62368.1:2022

## Hardware

### FRONT VIEW

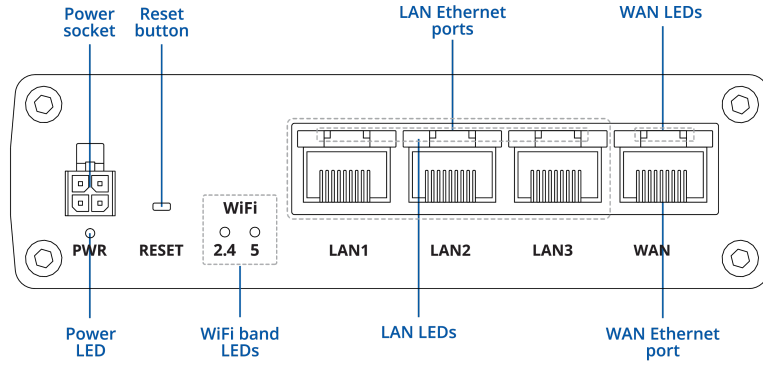

### BACK VIEW

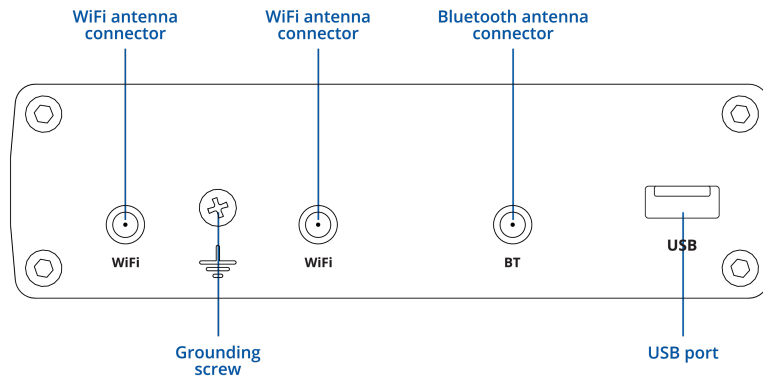

### POWER SOCKET PINOUT

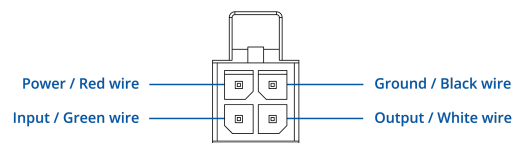

## Ordering

Standard package\*



RUTX10



QUICK START GUIDE



18W PSU



2 X WI-FI DUAL-BAND  
SMA ANTENAS



BLUETOOTH MAGNETIC  
SMA ANTENNA

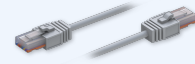

ETHERNET CABLE 1.5M

\*Standard package contents may differ based on standard order codes.

For more information on all available packaging options – please [contact us](#) directly.

## Classification codes

**HS Code:** 851762

**HTS:** 8517.62.00

### Available versions

---

RUTX10 *****	N/A	RUTX10000000 / Standard package with EU PSU RUTX10000200 / Standard package with US PSU RUTX10000300 / Standard package with UK PSU RUTX10000400 / Standard package with AU PSU RUTX10000H00 / Standard package with JP PSU RUTX10000B00 / Standard package with Power cable with 4- way screw terminal RUTX10000C00 / Mass packing code
--------------	-----	--

**TOP VIEW**

The figure below depicts the measurements of device and its components as seen from the top:

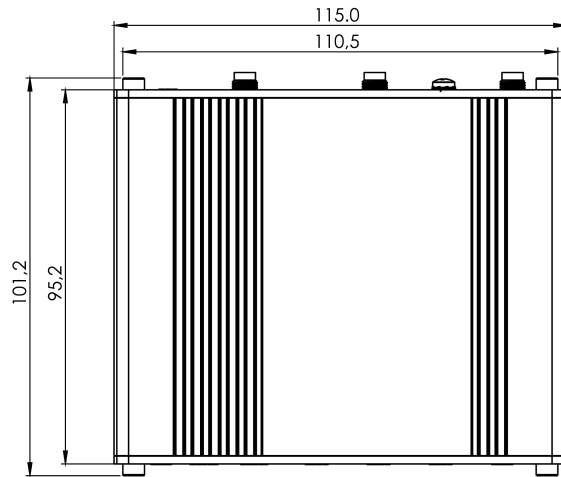

**RIGHT VIEW**

The figure below depicts the measurements of device and its components as seen from the right side:

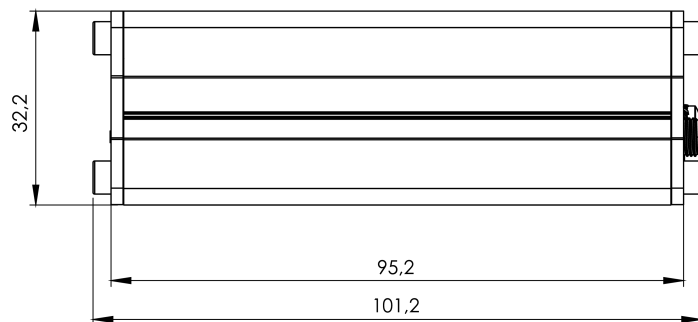

**FRONT VIEW**

The figure below depicts the measurements of device and its components as seen from the front panel side:

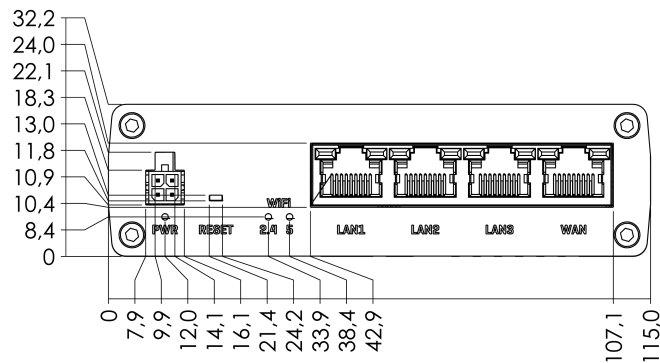

## REAR VIEW

The figure below depicts the measurements of device and its components as seen from the back panel side:

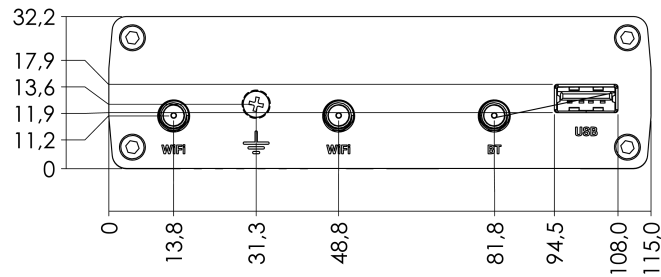

## MOUNTING SPACE REQUIREMENTS

The figure below depicts an approximation of the device's dimensions when cables and antennas are attached:

